

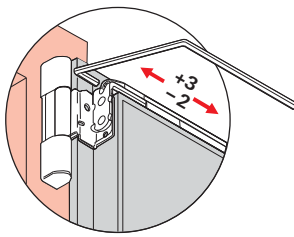

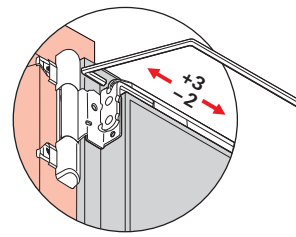
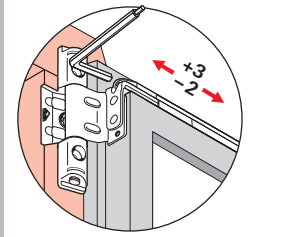
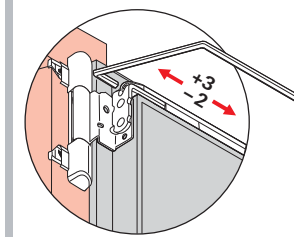
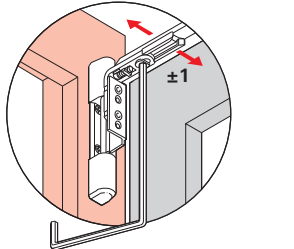
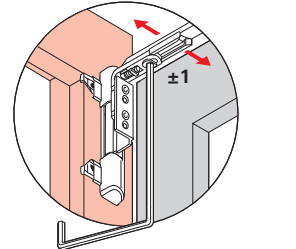
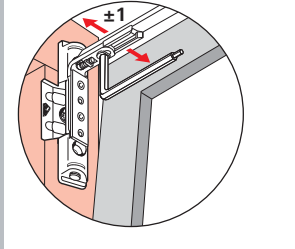
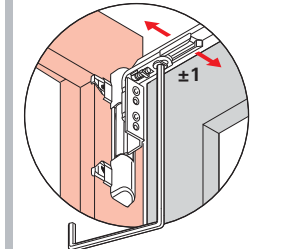
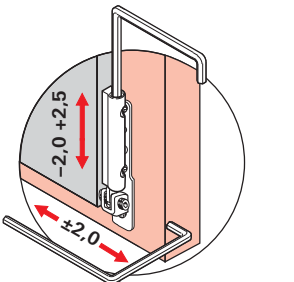
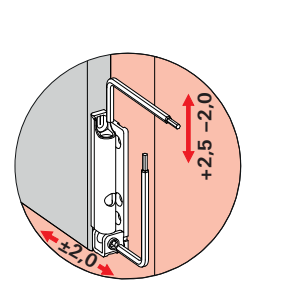
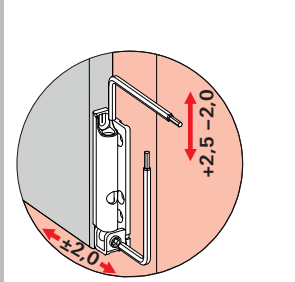
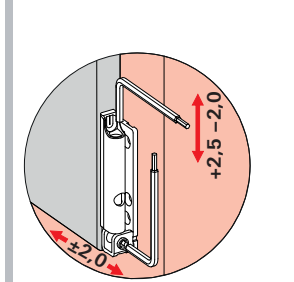

Le réglage des ferrures Roto ne peut être effectué que par un professionnel qualifié.

Fenêtres et portes fenêtres en PVC		Fenêtres et portes fenêtres en bois	
Côté paumelles K	Côté paumelles A *	Côté paumelles E5	Côté paumelles A *
<b>Palier de compas</b>			
			
			
<b>Palier d'angle</b>			
			
			

\* En cas d'utilisation de caches (palier de compas/palier d'angle), les plages de réglage sont modifiées.

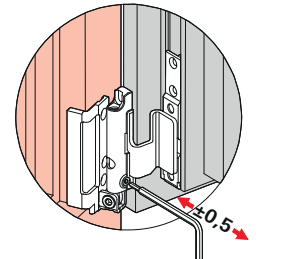
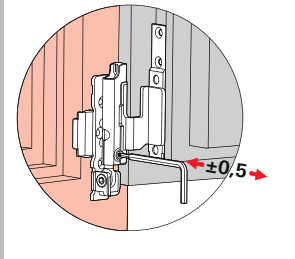
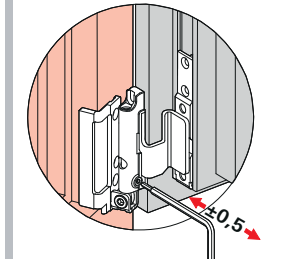
Outil de réglage		
Illustration	Description	N° d'article
	Cléf à six pans 4 mm	208 609
	Cléf à six pans 2,5/4 mm	230 764

**Roto Frank S.A.**  
Technologie pour fenêtres et portes

Rue du Bosquet 1 - Zoning Industriel II  
1400 Nivelles  
Téléphone +32 (0)67 89 41 40 • Téléfax +32 (0)67 84 14 56  
info.west@roto-frank.com • www.roto-frank.be



### Goujons E

Outil de réglage	Angle de réglage en °	Réglage pression de fermeture en mm
	Grundstellung 0°	-

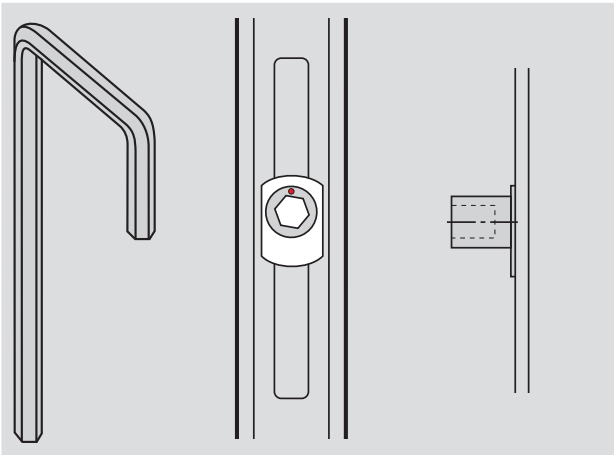
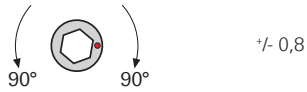

### Goujons P

Outil de réglage	Angle de réglage en °	Réglage pression de fermeture en mm
	Grundstellung 0°	-

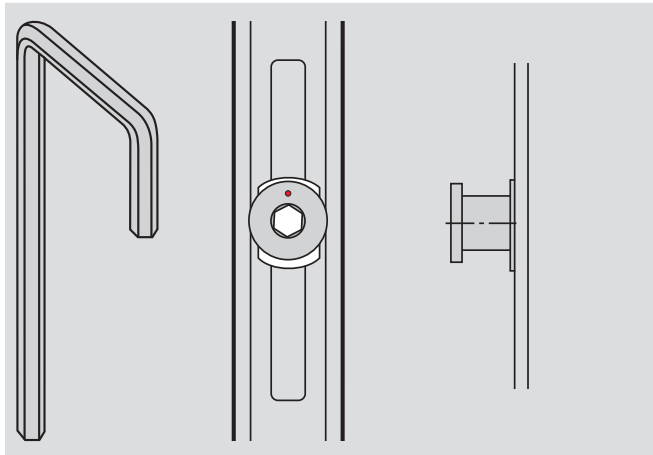
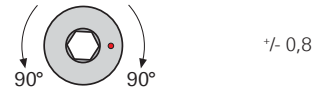

### Goujons V

Outil de réglage	Angle de réglage en °	Réglage pression de fermeture en mm	Réglage hauteur en mm
------------------	-----------------------	-------------------------------------	-----------------------

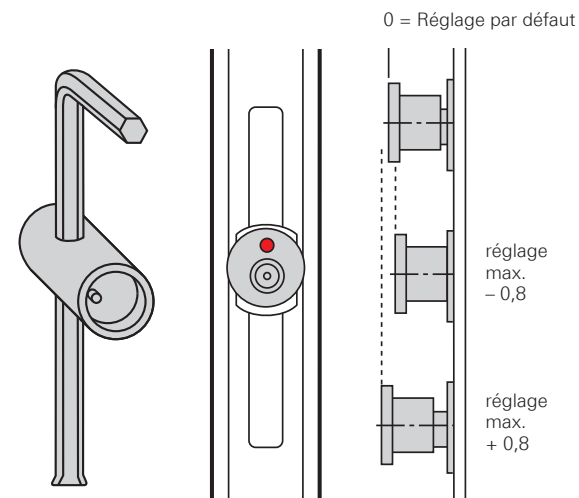

	Réglage par défaut 0°	-	-
	90° 90°	+/- 0,8	+/- 0,2
	180° 180°	-	+/- 0,4
	270° 270°	+/- 0,8	+/- 0,6
	360° 360°	-	+/- 0,8

